

Article number: 439600340

Description: Rota-fix shaft-hub connection FS340x425

Note: Self centering - very high torque.

Measures

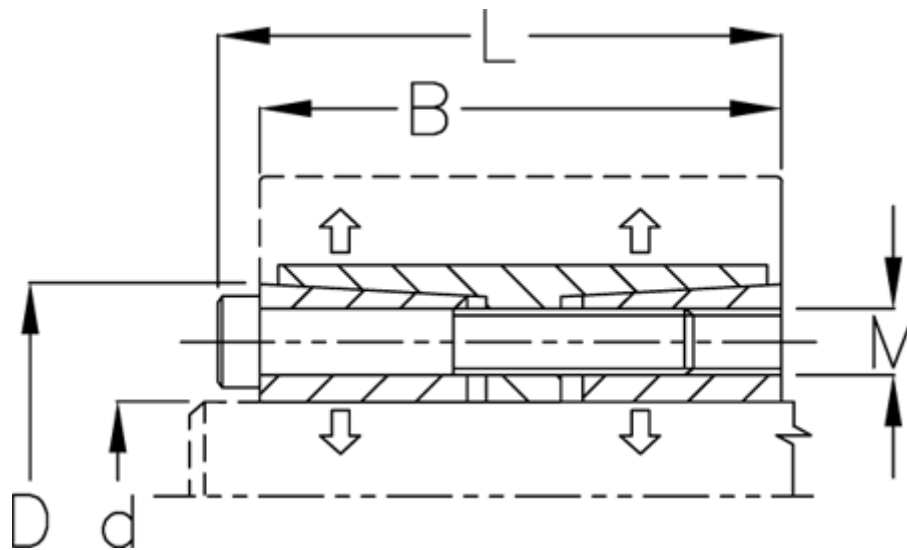

B mm	= 136
d H8 mm	= 340
D mm	= 425
Fit tolerance	= Aksel h8, Nav H8
F kN torque	= 2247.0
L mm	= 156
M mm	= M20
P N/mm ² surface pressure on shaft/hub	= 147

Surface roughness	= R? ? 3.2 μm
T N m torque	= 382000
Ts N m bolt tightening torque	= 690.0